

DEADBOLT LOCKS HORIZONTAL MOUNT

- TWO STYLES AVAILABLE
- REQUIRES 16.5 MM DIAMETER HOLE
- ATTRACTIVE TOUGH NYLON HOUSING
- MOUNTS IN 3/4" MATERIAL

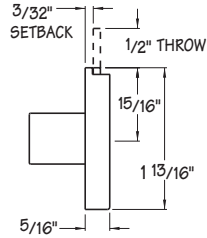

CB-230
TYPE 230
CYLINDER BODY



CB-231
TYPE 231
CYLINDER BODY

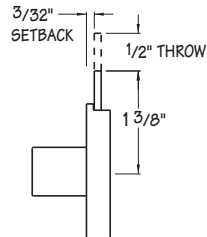

SP-250
STRIKE
PLATE

CB-232
TYPE 232
CYLINDER BODY

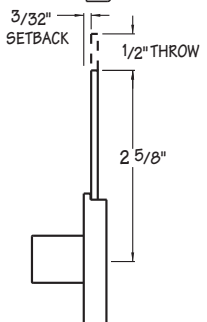

CB-234
TYPE 234
CYLINDER BODY

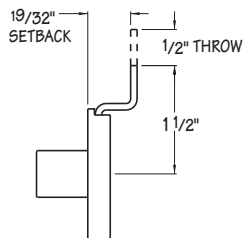

CB-235
TYPE 235
CYLINDER BODY

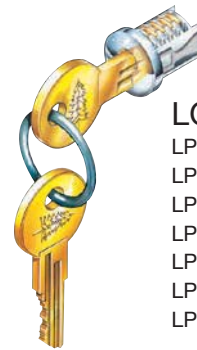
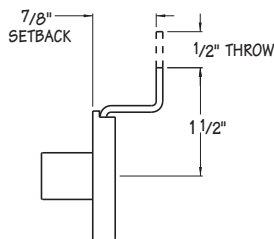

LOCK PLUGS

- LP-100 Nickel
- LP-200 Old English
- LP-300 Black
- LP-400 Statuary Bronze
- LP-500 Brass
- LP-700 Satin Nickel
- LP-800 White

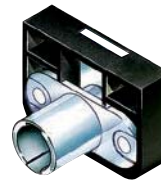

CB-280
TYPE 280
CYLINDER BODY

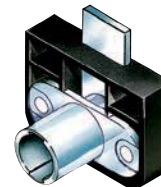
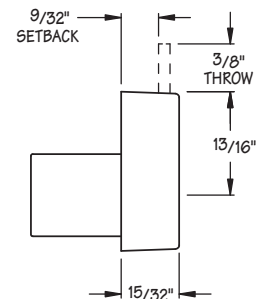

CB-281
TYPE 281
CYLINDER BODY

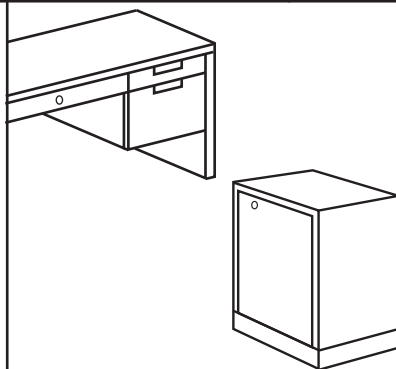
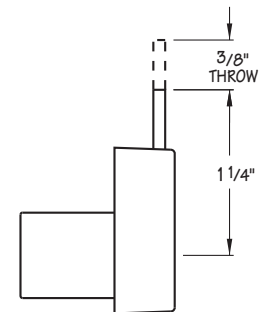

DEADBOLT LOCKS VERTICAL MOUNT

- TWO STYLES AVAILABLE
- REQUIRES 16.5 MM DIAMETER HOLE
- ATTRACTIVE TOUGH NYLON HOUSING
- MOUNTS IN 3/4" MATERIAL

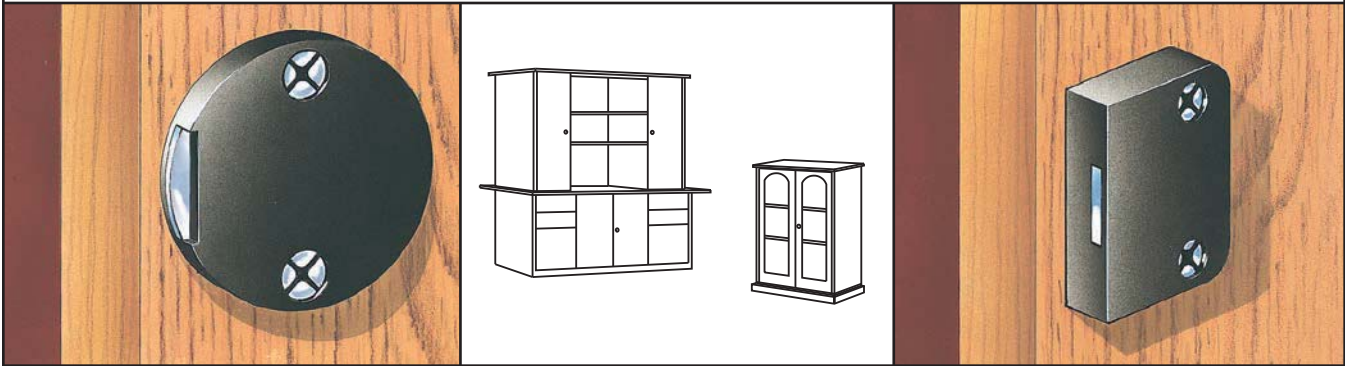

CB-240
TYPE 240
CYLINDER BODY

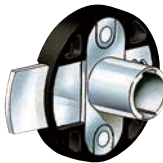
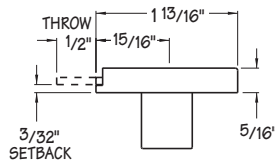

CB-241
TYPE 241
CYLINDER BODY

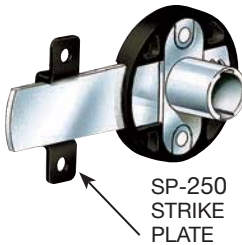
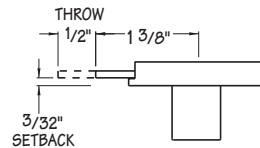

CB-242
TYPE 242
CYLINDER BODY

SP-250
STRIKE
PLATE

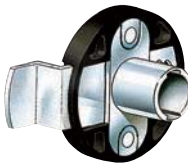
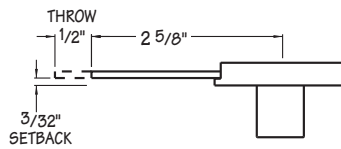

CB-244
TYPE 244
CYLINDER BODY

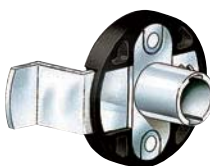
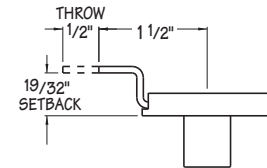

CB-245
TYPE 245
CYLINDER BODY

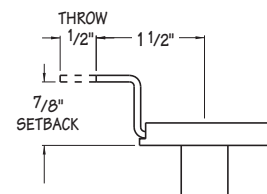

CB-290
TYPE 290
CYLINDER BODY

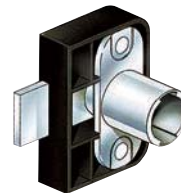
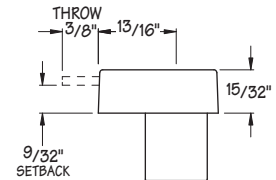

CB-291
TYPE 291
CYLINDER BODY

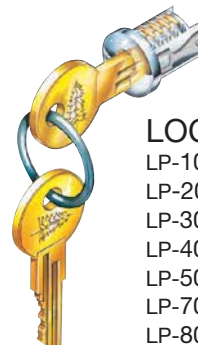
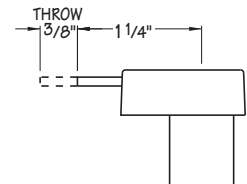

LOCK PLUGS

- LP-100 Nickel
- LP-200 Old English
- LP-300 Black
- LP-400 Statuary Bronze
- LP-500 Brass
- LP-700 Satin Nickel
- LP-800 White

