

DOOR BOTTOM

Automatic, Handed

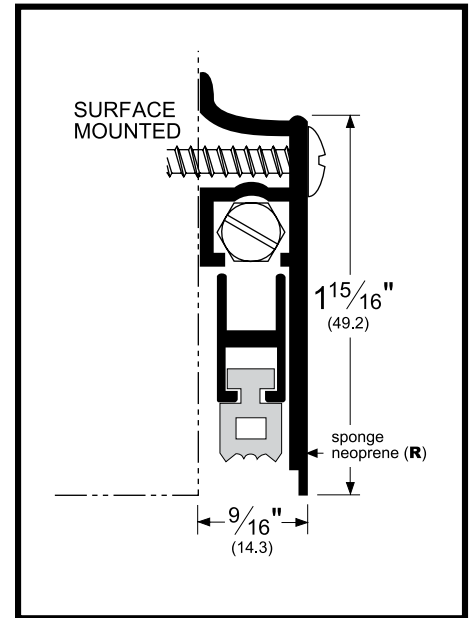

About Door Bottom Seals:

Pemko Door Bottom Seals consist of a variety of solutions for sealing a door to the threshold or floor surface.

About Automatic Door Bottoms:

Pemko Automatic Door Bottoms consist of an aluminum case which surrounds a movable drop bar seal. The drop bar seal is actuated by a plunger which contacts the jamb as the door is closing, forcing the drop bar seal down against the floor or threshold. Automatic Door bottoms are frequently used when an automatic door bottom is required to close over carpet.

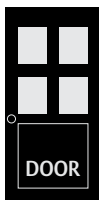

↑
Seals
Bottom
of Door

- Low closing force.
- Provide excellent seals to keep out draft, dust, moisture, insects, fumes, light and sound.
- End plates provided for all mounting applications.
- Slotted holes for adjustment.

Product / Available Finishes:

- 412BRL** Extruded Bronze [Brass] Anodized Aluminum with Black Sponge Neoprene insert
- 412CRL** Clear Anodized Aluminum with Black Sponge Neoprene insert
- 412DRL** Dark Bronze Anodized Aluminum with Black Sponge Neoprene insert
- 412GRL** Gold Anodized Aluminum with Black Sponge Neoprene insert
- 412SRL** Clad Stainless Steel with Black Sponge Neoprene insert

Testing/Ratings:



Tools Required:

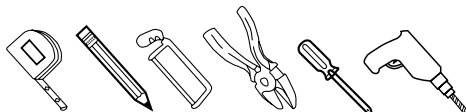

Parts Included in End Cap Kit:

PARTS INCLUDED IN END PLATE KIT:

NUMBER	DESCRIPTION	QUANTITY
1	Fasteners	2
2	End Cap	1

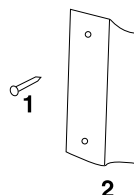

Installation Instructions:

These patent pending Automatic Door Bottoms are surface mounted or semi-mortise mounted types.

NOTE: If fire labeling is required, door construction must be approved for semi-mortise.

1. Disassembly and reassembly of the mechanism is required to reverse the hand. For fitting, these door bottoms may be cut down a maximum of 2". The sheet metal screws provided (Type AB) will accommodate both hollow metal or wood door installations.
2. Cut from end opposite actuating plunger only.
3. DO NOT cut off more than two (2) inches.
4. All models may be reversed for left or right hand installations. All models may be trimmed down 2". However, it is necessary to determine the hand and reverse the mechanism (if required) prior to cutting down the unit to fit the door.
5. To reverse (see Figure 1), remove the small anchoring screw on the back of the unit, and slide out the drop bar and plunger assemblies together. Replace these assemblies in the opposite end, line up the hole in the end anchor with the pre-drilled hole in the case, and replace the retaining screw.

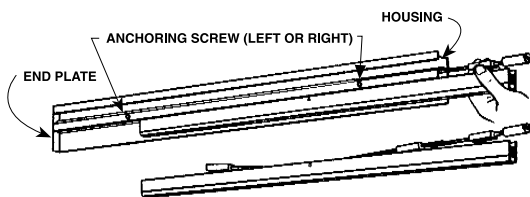
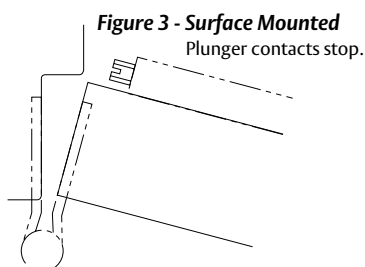
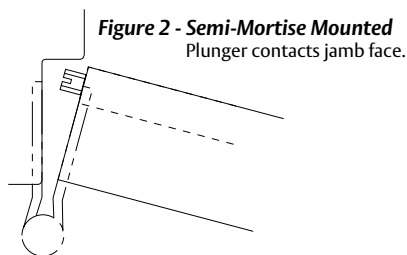

Figure 1 - Reversing the Mechanism

6. After the hand is determined and the unit is cut to size (cut end opposite plunger), with the actuating plunger at the hinge side, fasten the door bottom to the door with the screws provided.
 - For semi-mortise mounted installation, the plunger contacts the jamb face (as shown in Figure 2).
 - For surface mounted installation, the plunger contacts the stop (as shown in Figure 3).



7. The underside edge of the door bottom case should be flush with the bottom of the door. For wood jambs, a #10 x 1/2" flat head screw is furnished for installation at the point where the plunger contacts the jamb to prevent indenting.
8. All models may be set to seal up to a 5/8" gap under the door by turning the adjusting screw on the plunger counter clockwise until seal just touches the floor surface when the door is closed. It is not necessary to squash the seal against the floor for a good seal.

www.pemko.com

© 2007 Pemko Manufacturing Co.
412_RL_WEBINS
Rev 1 - 07.01.07

End Plate Installation Instructions:

PLEASE READ THESE INSTRUCTIONS THOROUGHLY BEFORE ATTEMPTING TO INSTALL END PLATES.

IMPORTANT! These parts are made from glass filled nylon. They are very strong, but brittle. Do not attempt to twist or bend them or they will break. This is not a problem if properly installed or removed.

1. The automatic door bottom must be correctly installed and adjusted in accordance with the installation instructions furnished with this product (see other side).
2. Be sure that the drop bar (part that contains the seal) does not project beyond the end of the case when the actuation plunger is depressed. If it does project beyond the case, it was improperly trimmed in the field. This condition can be corrected by removing the unit and trimming the excess.

NOTE: Under no condition should the insert project beyond the edge of the case.

3. Install the flat end cover plate on the lock edge of the door with the fasteners provided.



UNITED STATES:

VENTURA, CA
Ph: 800.283.9988
Fax: 800.283.4050

MEMPHIS, TN
Ph: 800.824.3018
Fax: 800.243.3656

CANADA:

VANCOUVER, BC
Ph: 877.535.7888
Fax: 877.535.7444

TORONTO, ON
Ph: 866.243.9816
Fax: 866.243.9817

www.pemko.com

© 2007 Pemko Manufacturing Co.
412_RL_WEBINS
Rev 1 - 07.01.07