

Universal hinges for wooden doors

Technical features

Universal hinges can provide a solution to a number of special applications, which include half-inset doors and doors with moulded profiles.

Bright nickel plated die-cast cup and arm.

Dimensions of the 35 mm cup.

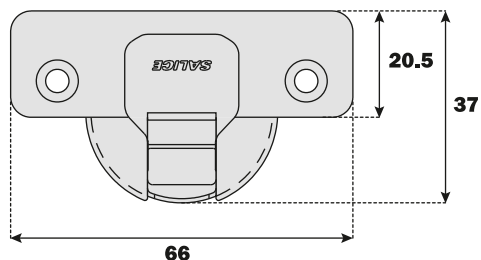

Constant "L" value of 0.7 mm (it does not change during side adjustment).

Approx. number of hinges required according to the door dimension and weight.

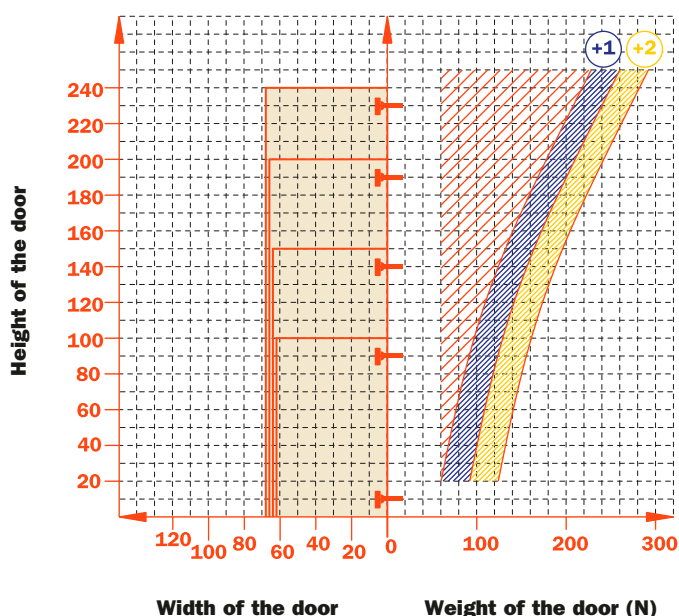

Adjustments

Compensated side adjustment from -1.5 mm to +4.5 mm.
Height adjustment ± 2 mm.
Depth adjustment with Series 200 mounting plates +2.8 mm.
Depth adjustment with Domi snap-on mounting plates from -0.5 mm to +2.8 mm.
Anti-sliding safety stop.

Mounting plates

Symmetrical and asymmetrical bright nickel plated steel or die-cast Series 200 mounting plates.
Snap-on assembly on Domi mounting plates.
Positioning with pre-determined stop on traditional Series 200 mounting plates.

N.B. : Use POZIDRIVE No. 2 screwdrivers for all screws.

	<p>48 $\varnothing 35$ 6 110°</p>	<p>45 $\varnothing 35$ 9.5 110°</p>	<p>52 $\varnothing 35$ 5.5 110°</p>
<p>Wood screw</p>	A	P	U
	<p>48 $\varnothing 35$ 6 $\varnothing 10$ 110°</p>	<p>45 $\varnothing 35$ 9.5 $\varnothing 8$ 110°</p>	<p>52 $\varnothing 35$ 5.5 $\varnothing 10$ 110°</p>
<p>Dowel</p>	B	R	W

Use this table to identify the available drillings and fixings.

Fill the third position of the hinge code number with the letter or the number corresponding to your choice. I.e.: CB_2AC9.

↑
 Fill this position with the chosen letter or number.

Universal hinges - For wooden doors - 110° opening



Technical information

These hinges can provide a solution to a number of special applications, which include half-inset doors and doors with moulded profiles.

9 mm deep metal cup.
 110° opening. To limit the opening of the hinge, see page 14 chapter "Accessories".
 Possible drilling distance on the door (K): from 3 to 18 mm.
 Compatible with all traditional Series 200 mounting plates and with all Domi snap-on mounting plates.

Space needed to open the door

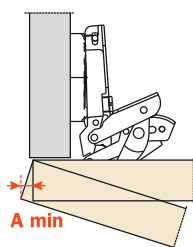

	T=	16	18	20	22	24	26
K=3	A=	0.0	0.0	0.0	0.0	0.3	1.4
K=4	A=	0.0	0.0	0.0	0.0	0.4	1.5
K=5	A=	0.0	0.0	0.0	0.0	0.5	1.9
K=6	A=	0.0	0.0	0.0	0.0	0.7	2.6
K=7	A=	0.0	0.0	0.0	0.0	11.3	12.8
K=8	A=	0.0	0.0	0.0	0.0	10.3	12.9
K=9	A=	0.0	0.0	0.0	0.0	9.3	11.9
K=10	A=	0.0	0.0	0.0	6.0	8.3	10.9
K=11	A=	0.0	0.0	0.0	5.1	7.3	9.9
K=12	A=	0.0	0.0	0.0	4.1	6.3	8.9
K=13	A=	0.0	0.0	1.4	3.3	5.3	7.9
K=14	A=	0.0	0.0	0.7	2.6	4.5	6.9
K=15	A=	0.0	0.0	0.2	2.0	3.8	5.9
K=16	A=	0.0	0.0	0.0	1.4	3.2	5.0
K=17	A=	0.0	0.0	0.0	1.0	2.7	4.4
K=18	A=	0.0	0.0	0.0	0.7	2.2	3.9

The above values are calculated on the assumption that the doors have square edges. They are reduced if the doors have radiussed edges.

Projection of the door

Projection of the door from the cabinet side at the max. opening. The figures are based on H=0 mm thickness of mounting plate and K value = 3 mm.

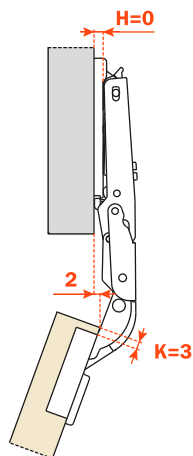

"C" value

With this formula you can obtain the max. thickness of the moulded door that can be opened without touching adjacent carcass sides, doors or walls, whilst bearing in mind the above K-T values.

$$C = 5.5 + K + A$$

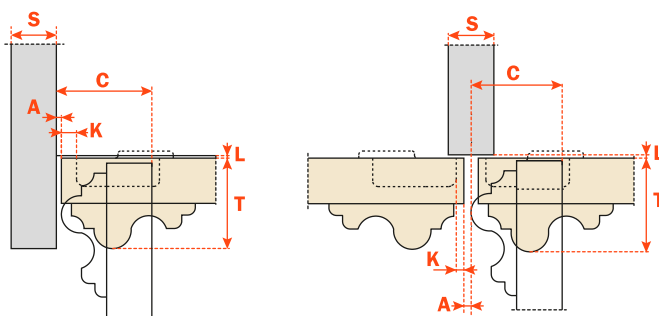

Packing

Boxes 150 pcs.
Pallets 3.600 pcs.

Use these formulas to determine the drilling distance "K" and the height of the mounting plate "H" which is necessary to solve each application problem.

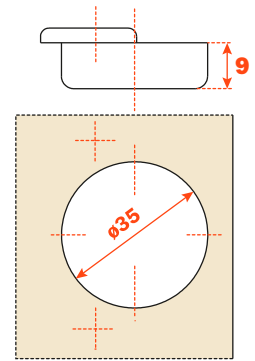

Arm 0

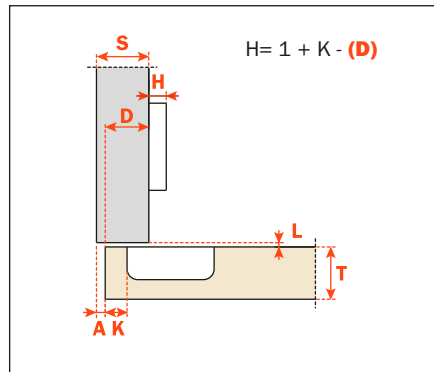
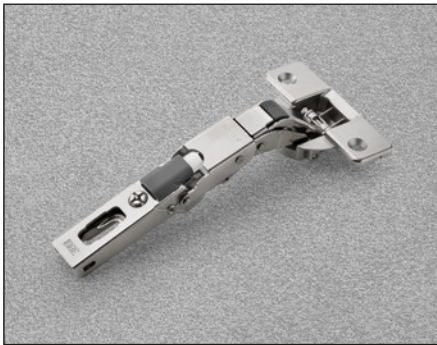

CB_2AE9 = with integrated soft-close

CB_2AC9 = sprung hinge

CB_QAC9 = with Push opening

CB_1AC9 = unsprung hinge

Drillings and fittings
at page 9.