



P513-610

B-Series Single Cylinder Deadbolt Cerrojo Cilíndrico Simple Serie B



Monocylindre de Série B

Models B660/760/860, B661/761/861
Modelos B660/760/860, B661/761/861
Modèles B660/760/860, B661/761/861

Installation Instructions
Instrucciones de Instalación
Instructions d'installation

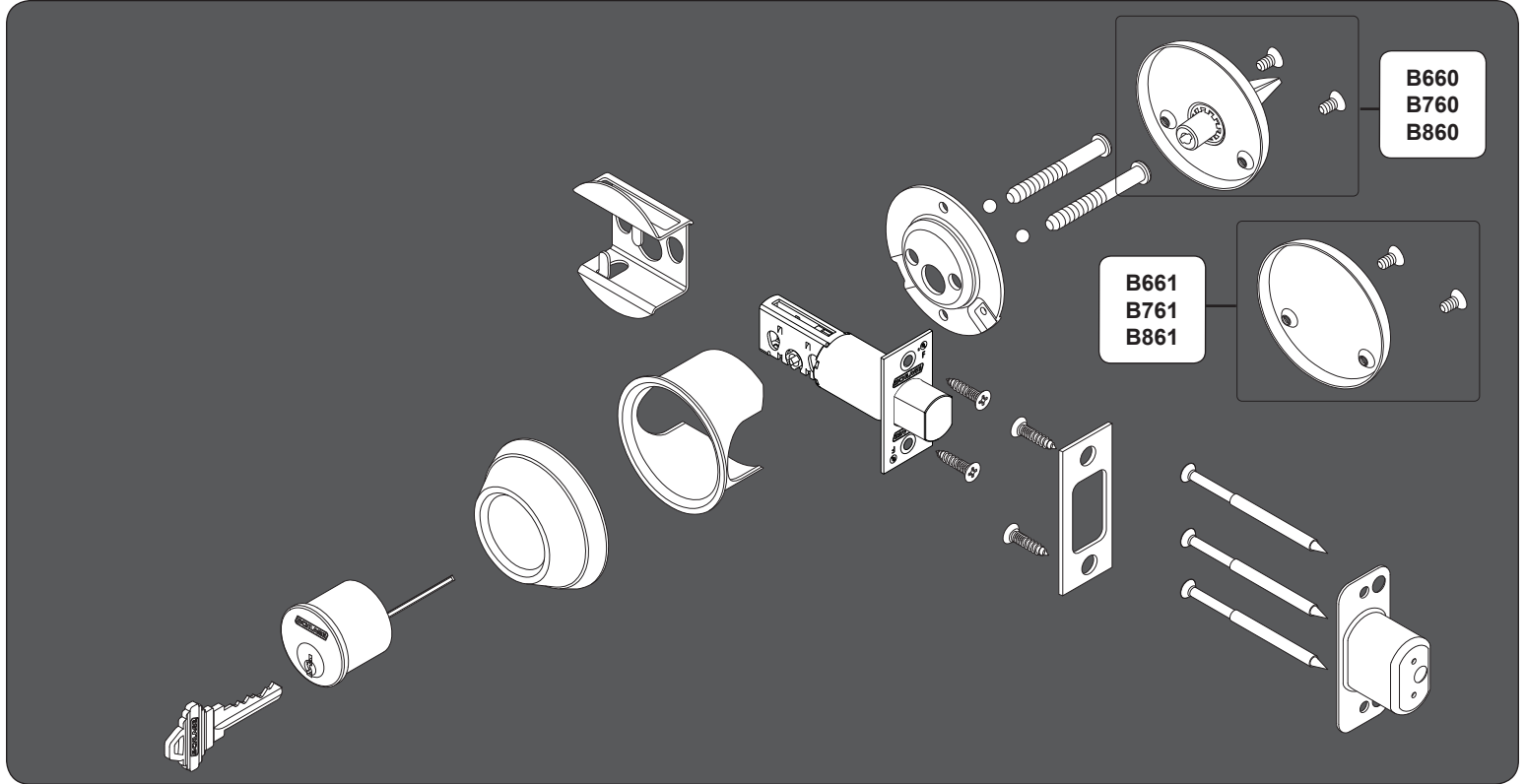

1

Mark door with template.
Marque la puerta con la plantilla.
Tracez la gabarit sur la porte.

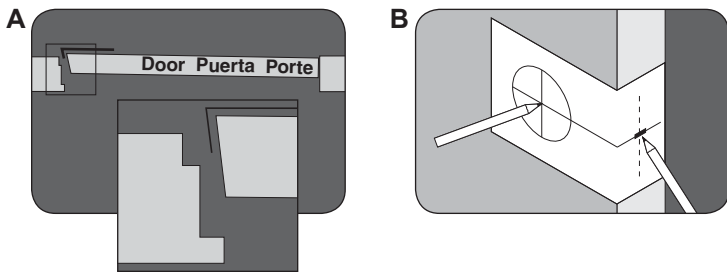

2

Drill 2 holes.
Taladre (2) agujeros.
Percez les (2) trous.

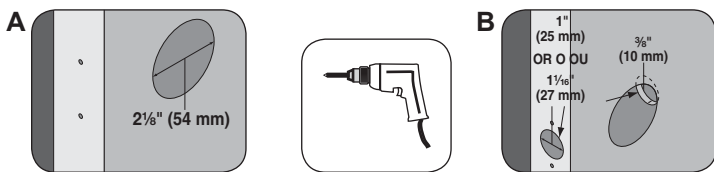

1" (25mm) for deadbolt, or 1 1/16" (27 mm) for circular bolt
1" (25mm) para cerrojo de seguridad, o 1 1/16" (27 mm) para perno circular
25 mm (1 po) pour le pêne dormant, ou 27 mm (1 1/16 po) pour boulon rond

3

Install Fire Cup (2 1/8" through bore only).
Instalar el protector contra incendios (solo núcleo pasante de 54 mm [2 1/8 pulg.]).
Installez la coupole contre l'incendie (2 1/8 po à travers l'alésage seulement).

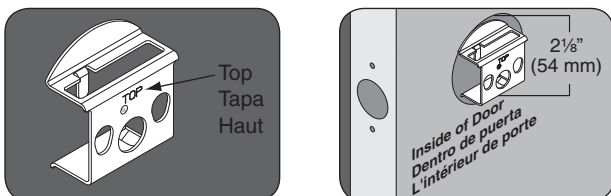

4

Install deadbolt
Instalación del cerrojo de seguridad
Installez le pêne dormant

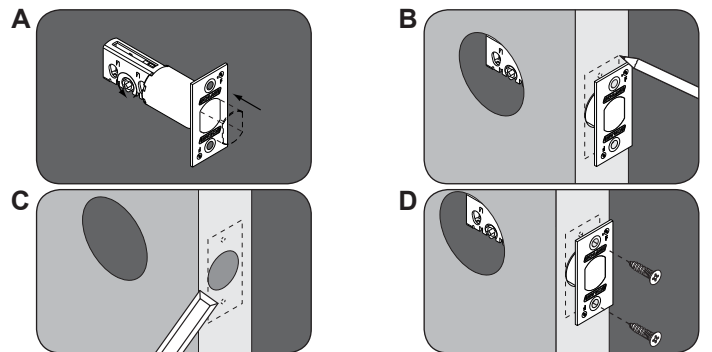

Install circular drive-in deadbolt.
Instale el cerrojo circular de seguridad.
Installez le pêne dormant circulaire.

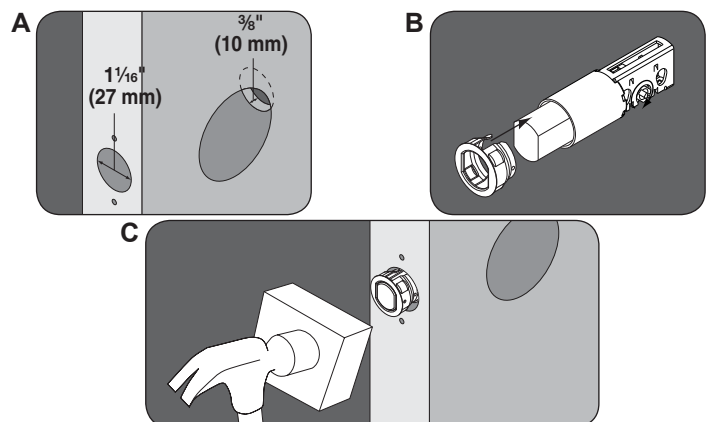

5

Prepare door jamb.
 Prepare la jamba de la puerta.
 Préparez le jambage de la porte.

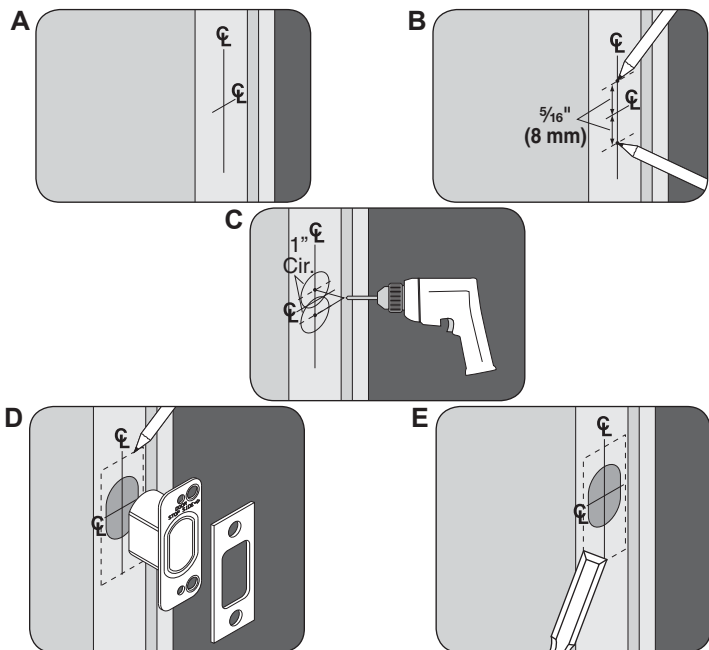

6

Install Strike Assembly.
 Instale el conjunto de piezas del recibidor.
 Installez les pièces de la gâche.

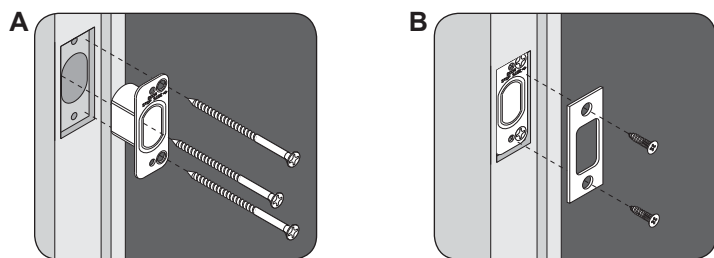

7

Install Outside Lock.
 Instalar la cerradura exterior.
 Installez le verrou extérieur.

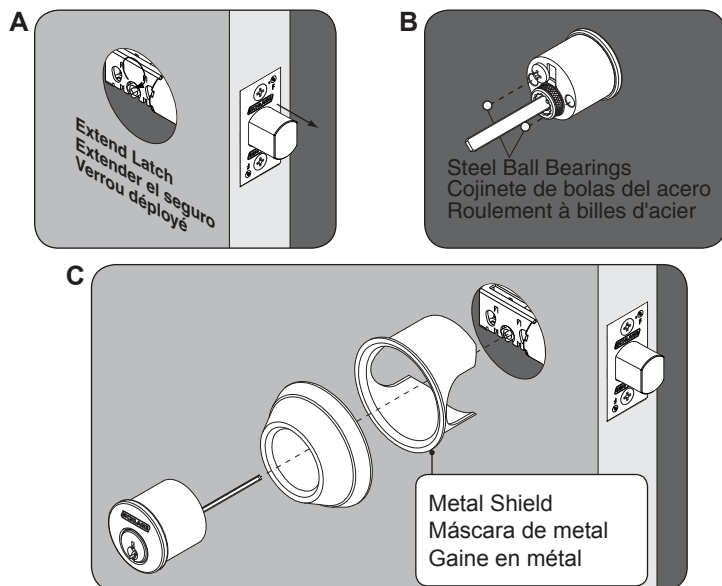

! IMPORTANT NOTES !

Do not use metal shield in existing 1 1/2" (38 mm) hole installations.
 Si utiliza un agujero previamente taladrado de 38mm, no haga uso de la rodela metálica incluida.
 S'il existe déjà un trou de 38mm, ne pas utiliser la gaine de sécurité fournie.

8

Install Mounting Plate (1 1/2" through bore only).
 Instalar la placa de montaje (solo núcleo pasante de 38 mm [1-1/2 pulg.]).
 Installez la plaque de fixation (1 1/2 po à travers l'alésage seulement).

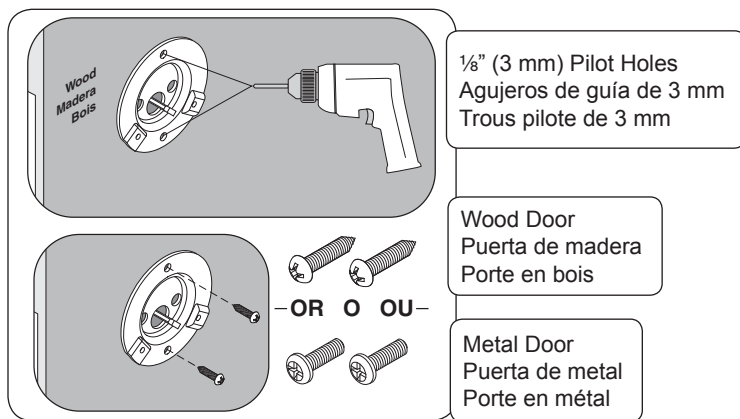

9

Install thumbturn.
 Instale el perno mariposa.
 Installez le verrou pousier.

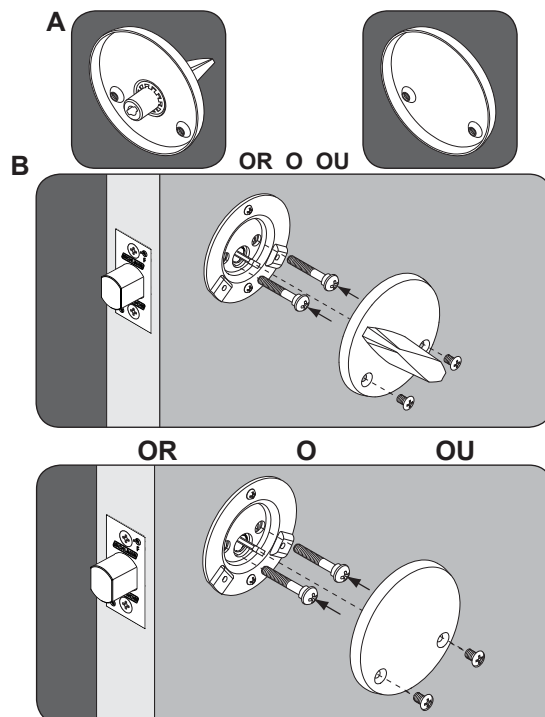

Customer Service Servicio al cliente Service à la clientèle
 1-877-671-7011 www.allegion.com/us

