

Pockit® LED Lights 3W

Required Items



Pockit Light Body 3W – Metal
with Surface Mount Ring
P/N: POC-3LEDSFR-M



DC Power Supply - 18W
Electronic
P/N: DC-ELT18-CON
Up to 6 (3W) Lights



- OR -

DC Power Supply - 60W
Electronic
P/N: DC-ELT60-CON
Up to 20 (3W) Lights

Optional Items



Touch On/Off Switch
P/N: TS2-72



Round Switch
P/N: RDSW



Roll Switch
P/N: ROLL SWITCH



Mounting Block
P/N: TRANS-MNT-BL
For Tresco DC Power
Supplies only, 60W MAX



Remote Control LED Dimmer
w/ (2) Remote Controls
P/N: LED-DIMRMT-12V8A



Manual Rotary Dimmer
P/N: LED-DIMCON

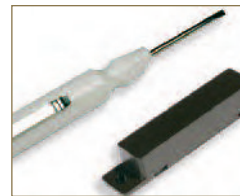

Magnet Switch Kit
P/N: AUSW-MAG



AMP® Connector
Connector for Light Body
P/N: MALE AMP



Extension Cord
P/N: LED-LINKD



Hole Saw & Mandrel Bit
P/N: DBSC57 (saw)
P/N: DBSC3 (mandrel)

All product dimensions and specifications are subject to change without prior notice.



Required Items

Light Body 3W - Metal

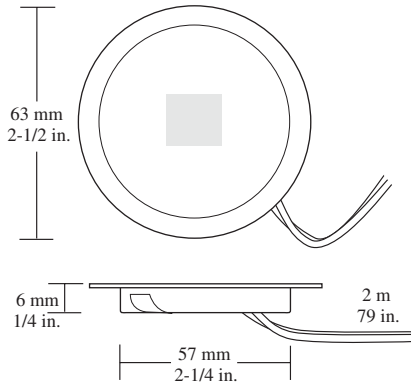

Description	Color Temp.	Finish Color	Part No.	Useful Life Hours	Hole Size Req'd for Recessing
Light Body 3W	Warm 3000K	White (WH)	POC-3LEDSFR-WWH	50,000	57 mm (2-1/4 in.)
		Black (BL)	POC-3LEDSFR-WBL		
		Chrome (CH)	POC-3LEDSFR-WCH		
		Nickel (NI)	POC-3LEDSFR-WNI		
		Antique Brass (AB)	POC-3LEDSFR-WAB		
	Cool 5000K	White (WH)	POC-3LEDSFR-CWH		
		Black (BL)	POC-3LEDSFR-CBL		
		Chrome (CH)	POC-3LEDSFR-CCH		
		Nickel (NI)	POC-3LEDSFR-CNI		
		Antique Brass (AB)	POC-3LEDSFR-CAB		

Pockit Metal Body includes Surface Mount Ring, AMP® Connector, and 2 m (79 in.) of wiring. All Pockit Lights can be either surface mounted or recess mounted.

Surface Mount Ring

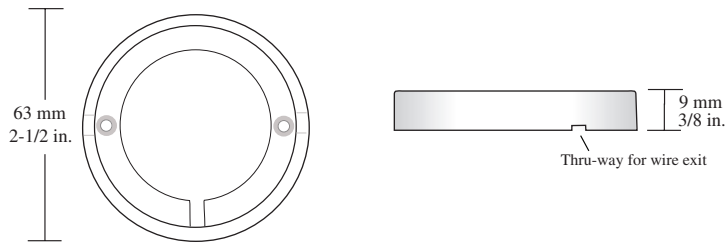

Surface Mount Ring is included with each light.

DC Power Supply - 18W

Electronic.

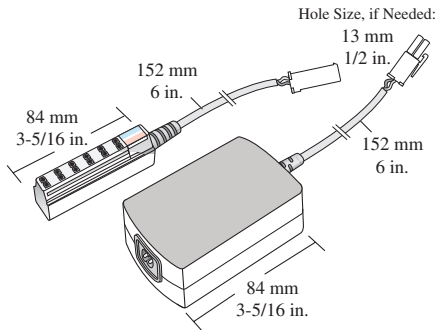

Description	Finish Color	Part No.	Dimmable
DC Power Supply 12VDC 18W	Black	DC-ELT18-CON	Trailing edge (12V side)

Mounting Block and Power Cord are included with each Power Supply.

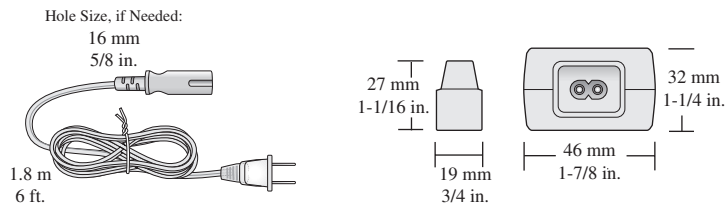

DC Power Supply - 60W

Electronic.

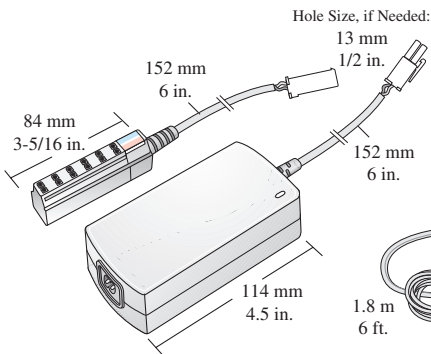

Description	Finish Color	Part No.	Dimmable	Hole Size if Needed
DC Power Supply 12VDC 60W	Black	DC-ELT60-CON	Trailing edge (12V side)	See drawing

Mounting Block and Power Cord are included with each Power Supply.

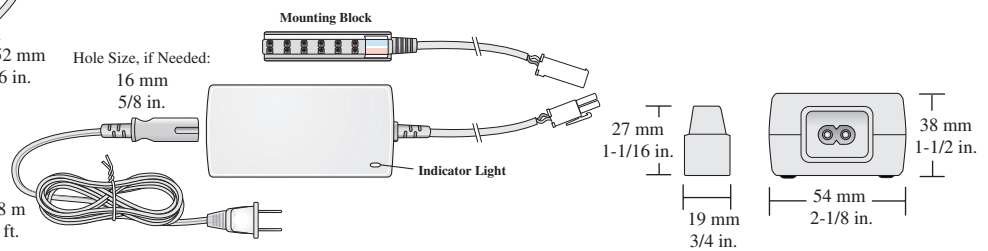

All product dimensions and specifications are subject to change without prior notice.

Optional Items

Touch On/Off Switch

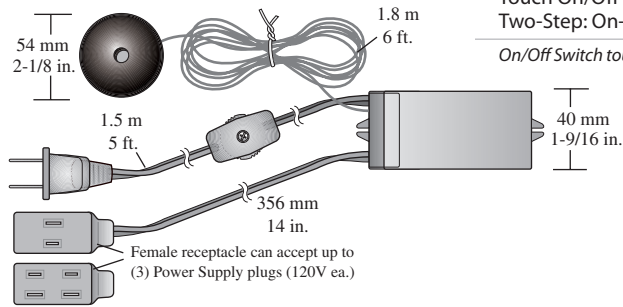

Description	Finish Color	Part No.
Touch On/Off Switch 200W Two-Step: On-Off	Black touch pad & body	TS2-72

On/Off Switch touch pad attaches to surface with adhesive backing. Power Supply plugs into On/Off Switch.

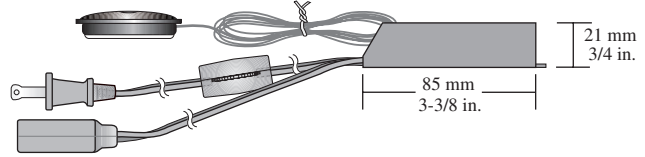

Round Switch - 12V

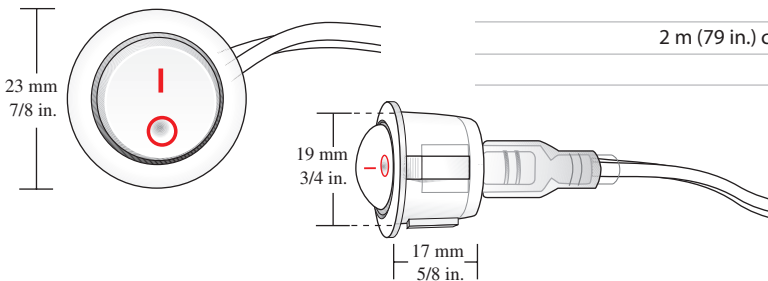

Description	Finish Color	Part No.	Hole Size Req'd
Round Switch 1 m (39 in.) cord	White (WH)	RDSW-1M-WH	19 mm (3/4 in.)
	Black (BL)	RDSW-1M-BL	
Round Switch 2 m (79 in.) cord	White (WH)	RDSW-2M-WH	19 mm (3/4 in.)
	Black (BL)	RDSW-2M-BL	

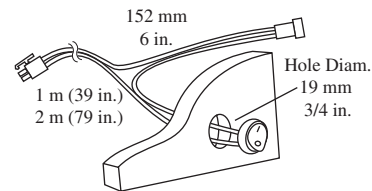

Roll Switch - 120V

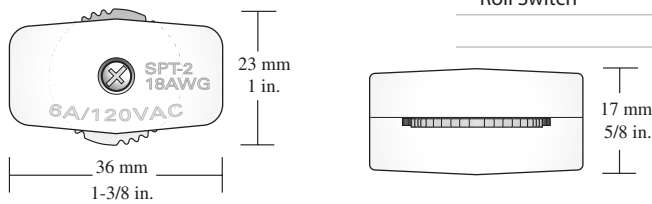

Description	Finish Color	Part No.
Roll Switch 120V	White	WHITE ROLL SWITCH
	Black	BLACK ROLL SWITCH

Mounting Block

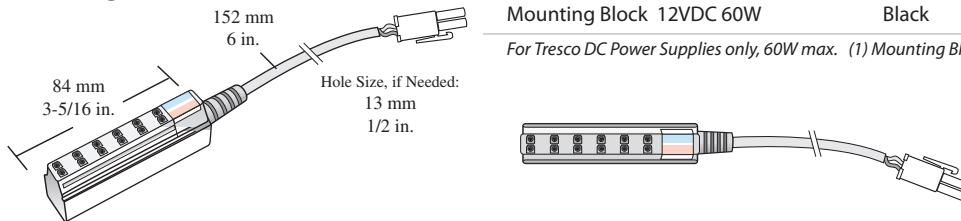

Description	Finish Color	Part No.
Mounting Block 12VDC 60W	Black	TRANS-MNT-BL

For Tresco DC Power Supplies only, 60W max. (1) Mounting Block is included with each Power Supply.

Remote Control LED Dimmer - 12V

w/ 2 Remote Controls

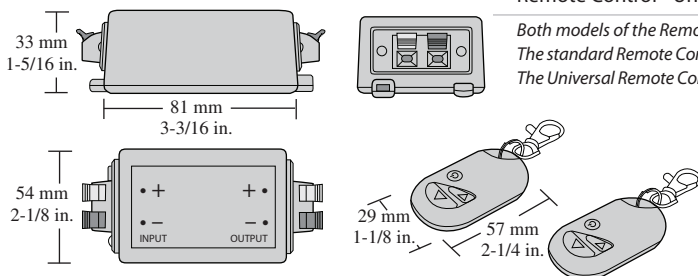

Description	Finish Color	Part No.
Remote Control	Black	LED-DIMRMT-12V8A
Remote Control - Universal		LED-DIMRMT-12V8A-U

Both models of the Remote Control LED Dimmer provide on/off power and dim lights from 1%–100%. The standard Remote Control independently controls one specific Dimmer in a room with other Dimmers. The Universal Remote Control (U) controls multiple Dimmers in a room.

All product dimensions and specifications are subject to change without prior notice.



Optional Items

Manual Rotary Dimmer

Description	Finish Color	Part No.
Manual Rotary Dimmer 4 Amps/48 Watts	White (WH)	LED-DIMCON-WH
	Black (BL)	LED-DIMCON-BL

The Manual Rotary Dimmer provides on/off power and dims lights from 1%–100%.

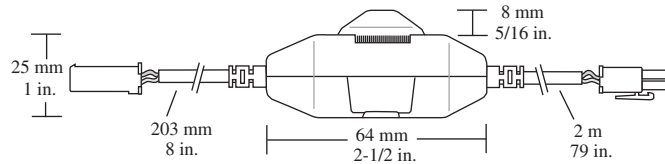
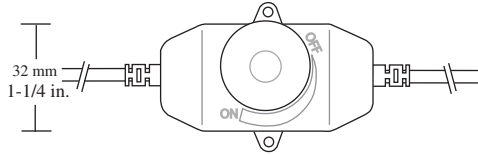

Magnet Switch Kit - 12V

Description	Finish Color	Part No.
Magnet Switch Kit 20W	White (WH)	AUSW-MAG-WH
	Brown (BR)	AUSW-MAG-BR

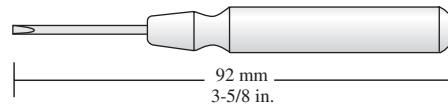
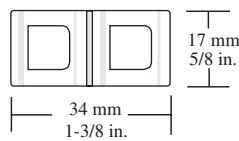
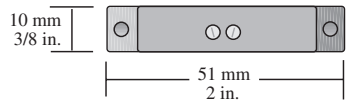

Wire manage clips with adhesive backing

AMP® Connector

Description	Finish Color	Part No.
AMP® Connector for Light Fixture	White	MALE AMP

AMP® Connector is included with each Light Fixture.

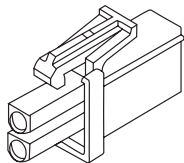

Extension Cord

Description	Length	Finish Color	Part No.	Hole Size if Needed
Extension Cord D	15 cm (6 in.)	Red/Black	LED-LINKD-15	13 mm (1/2 in.)
	25 cm (10 in.)		LED-LINKD-25	
	60 cm (24 in.)		LED-LINKD-60	
	120 cm (48 in.)		LED-LINKD-120	
	180 cm (72 in.)		LED-LINKD-180	

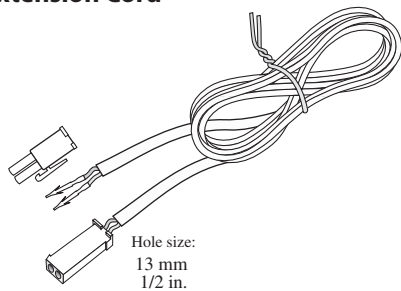

Hole Saw & Mandrel Bit

Description	Part No.	Hole Size
Hole Saw	DBSC57	57 mm (2-1/4 in.)
Mandrel Bit	DBSC3	

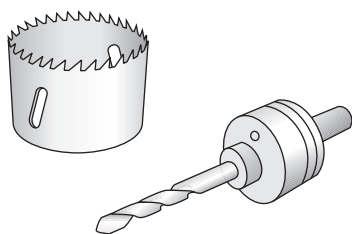

All product dimensions and specifications are subject to change without prior notice.